



To prevent accidents arising from the misuse of this controller, please ensure the operator receives this manual.

Safety precautions (Be sure to read these precautions before using our products.)

The safety precautions are classified into categories: "Warning" and "Caution". Depending on circumstances, procedures indicated by  Caution may be linked to serious results, so be sure to follow the directions for usage.

 **Warning** Procedures which may lead to dangerous conditions and cause death or serious injury, if not carried out properly.

 **Caution** Procedures which may lead to dangerous conditions and cause superficial to medium injury or physical damage or may degrade or damage the product, if not carried out properly.

 **Warning**

- To prevent an electric shock or fire, only our or other qualified service personnel may handle the inner assembly.
- To prevent an electric shock, fire or damage to the instrument, parts replacement may only be undertaken by our or other qualified service personnel.

 **Safety precautions**

- To ensure safe and correct use, thoroughly read and understand this manual before using this instrument.
- This instrument is intended to be used for industrial machinery, machine tools and measuring equipment. Verify correct usage after consulting purpose of use with our agency or main office. (Never use this instrument for medical purposes with which human lives are involved.)
- External protection devices such as protection equipment against excessive temperature rise, etc. must be installed, as malfunction of this product could result in serious damage to the system or injury to personnel. Also proper periodic maintenance is required.
- This instrument must be used under the conditions and environment described in this manual. We do not accept liability for any injury, loss of life or damage occurring due to the instrument being used under conditions not otherwise stated in this manual.

Caution with respect to Export Trade Control Ordinance

To avoid this instrument from being used as a component in, or as being utilized in the manufacture of weapons of mass destruction (i.e. military applications, military equipment, etc.), please investigate the end users and the final use of this instrument. In the case of resale, ensure that this instrument is not illegally exported.

 **Caution**

- This instrument should be used according to the specifications described in the manual.
If it is not used according to the specifications, it may malfunction or cause a fire.
- Be sure to follow the warnings, cautions and notices. Not doing so could cause serious injury or malfunction.
- Specifications of the JCD-33A and the contents of this instruction manual are subject to change without notice.
- Measures must be taken to ensure that the operator cannot touch power terminals or other high voltage sections.
- Be sure to turn the power supply to the instrument OFF before cleaning this instrument.
- Use a soft, dry cloth when cleaning the instrument.
(Alcohol based substances may tarnish or deface the unit.)
- As the display section is vulnerable, do not strike or scratch it with a hard object.
- Any unauthorized transfer or copying of this document, in part or in whole, is prohibited.
- Shinko Technos CO., LTD. is not liable for any damages or secondary damages incurred as a result of using this product, including any indirect damages.

1. Model

1.1 Model

JCD-33 A - R / M T5909-1 □, □□□		W96 x H96 x D100mm
A1	A	A1 output (Alarm type can be selected by keypad) *1
OUT1	R	Limit control output (Relay contact: 1a)
Input	M	Multi-range *2
Control action	T5909-1	High limit or low limit control action
Supply voltage		100 to 240V AC (standard)
		1 24V AC/DC *3
Option		A2 A2 output (Alarm type can be selected by keypad) *1
		C5 Serial communication (RS-485)
		TC Terminal cover
		BK Color: Black

*1: Alarm actions (9 types and No alarm action) and Energized/Deenergized can be selected by keypad.

*2: Thermocouple, RTD, DC current and DC voltage can be selected by keypad.

*3: Supply voltage 100 to 240V AC is standard. When ordering 24V AC/DC, enter "1" after the input code.

+

1.2 How to read the model label

Model labels are attached to the case and the inner assembly.

(1) Model
 (2) Option, supply voltage ("1" is entered only for 24V AC/DC)
 (3) Serial number (Only on inner assembly)

(Model label) (e.g.)

(1)-----	JCD-33A-R/M T5909-1	Relay contact output /Multi-range input
(2)-----	1	A2 output
	A2	
	MULTI RANGE	
(3)-----	No. 06KF05000	

2. Name and functions of the sections

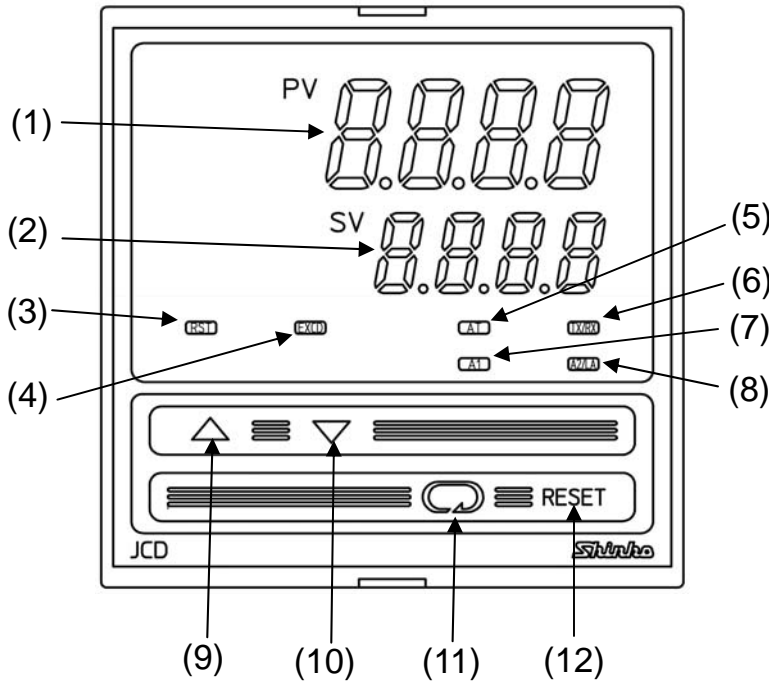

(Fig. 2-1)

- (1) **PV display**
Indicates the PV (process variable) with a red LED.
Indicates setting item characters during the setting mode.
- (2) **SV display**
Indicates the SV (desired value) with a green LED.
Indicates set (selected) value during the setting mode.
- (3) **RST (RESET) indicator**
Lights when OUT1 NO contact (terminals between 5 and 6) is OFF with a green LED.
- (4) **EXCD (EXCEEDED) indicator**
High limit action: The yellow LED lights when $PV \geq SV$.
Low limit action: The yellow LED lights when $PV \leq SV$.

(5) **AUTO indicator**

The yellow LED lights for Auto limit control action.

(6) **TX/RX indicator**

The yellow LED lights during Serial communication TX output (sending) (C5 option).

(7) **A1 indicator**

When Alarm 1 output is ON, the red LED lights.

(8) **A2 indicator**

When Alarm 2 output is ON, the red LED lights.

(9) **Increase key** (\triangle)

Increases the numerical value, switches the setting item during the setting mode.

(10) **Decrease key** (∇)

Decreases the numerical value, switches the setting item during the setting mode.

(11) **Mode key** (\odot)

Switches setting mode, and registers the set (selected) value.

(12) **RESET key** (RESET)

Resets OUT1 (limit control output).



Notice

When setting the specifications and functions of this controller, connect terminals 2 and 3 for power source first, then set them referring to Chapter “5. Settings” before performing “3. Mounting to the control panel” and “4. Wiring”.

3. Mounting to the control panel

3.1 Site selection



Caution

- Use within the following temperature and humidity ranges.
Temperature: 0 to 50°C (32 to 122°F), Humidity: 35 to 85%RH (No condensation, no icing)
- When this unit is installed through the control panel, the ambient temperature of this unit must be kept to under 50°C. Otherwise the life of electronic components (especially electrolytic capacitors) will be shortened.

This instrument is intended to be used under the following environmental conditions (IEC61010-1): Overvoltage category II, Pollution degree 2

Ensure the mounting location corresponds to the following conditions:

- A minimum of dust, and an absence of corrosive gases
- No flammable, explosive gases
- Few mechanical vibrations or shocks
- No exposure to direct sunlight, an ambient temperature of 0 to 50°C (32 to 122°F) that does not change rapidly
- An ambient non-condensing humidity of 35 to 85%RH
- No large capacity electromagnetic switches or cables through which large current flows
- No water, oil or chemicals or where the vapors of these substances can come into direct contact with the controller

3.2 External dimensions (Scale: mm)

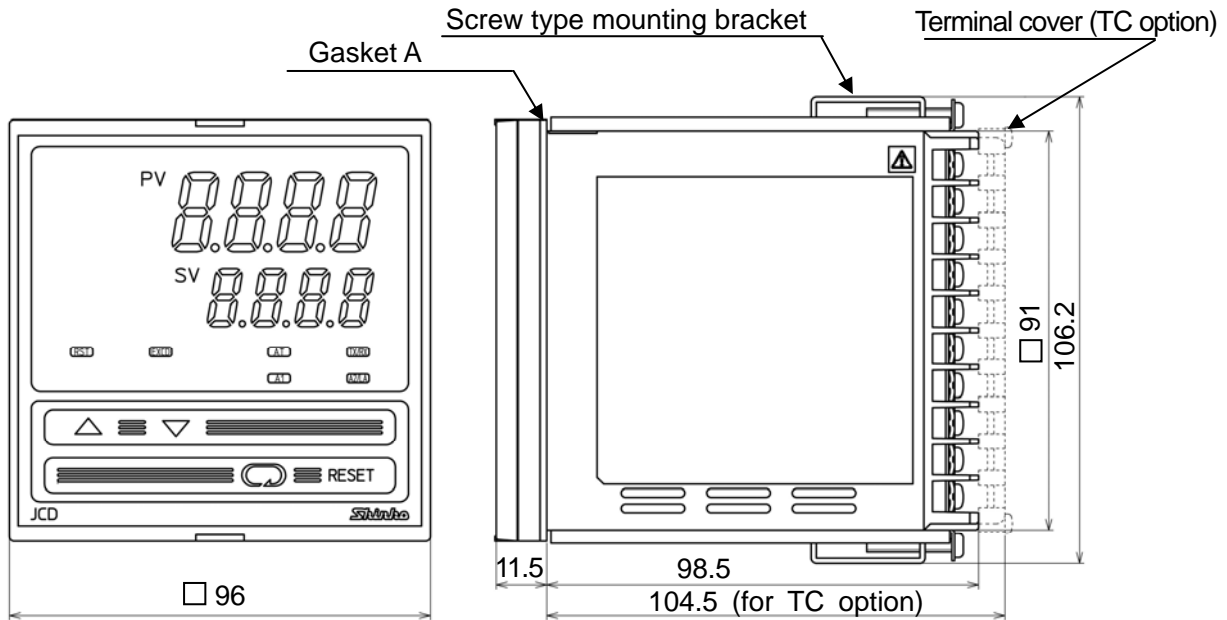

(Fig. 3.2-1)

3.3 Panel cutout (Scale: mm)

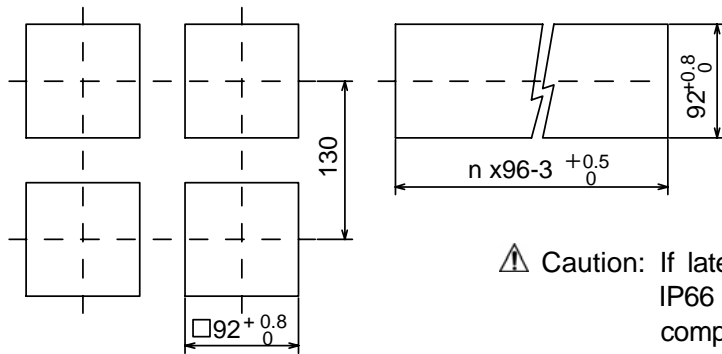

Lateral close mounting
n: Number of units mounted

⚠ Caution: If lateral close mounting is used for the controller, IP66 specification (Dust-proof/Drip-proof) may be compromised, and all warranties will be invalidated.

(Fig. 3.3-1)



Caution

As the case is made of resin, do not use excessive force while screwing in the mounting bracket, or the case or screw type mounting bracket could be damaged. The torque is approximately 0.12N•m.

3.4 Mounting

Mount the controller vertically to ensure it adheres to the Dust-proof/Drip-proof specification (IP66).

Mountable panel thickness: 1 to 15mm

(1) Insert the controller from the front side of the panel. (Fig.3.4-1)

(2) Attach the mounting brackets by the holes at the top and bottom of the case and secure the controller in place with the screws. (Fig.3.4-2)

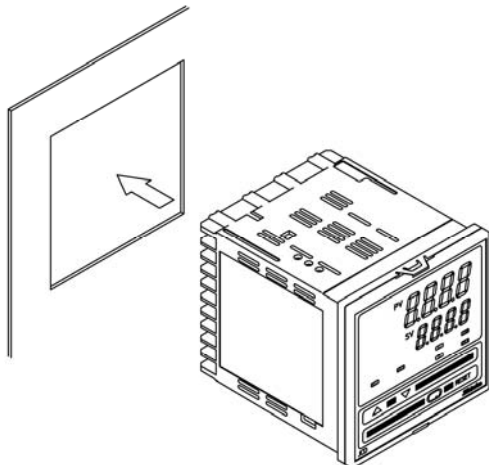

(Fig.3.4-1)

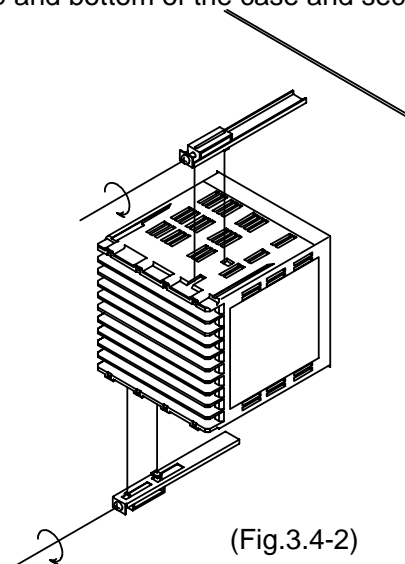

(Fig.3.4-2)

4. Wiring

Warning

Turn the power supply to the instrument off before wiring or checking.
Working or touching the terminal with the power switched on may result in severe injury or death due to Electric Shock.

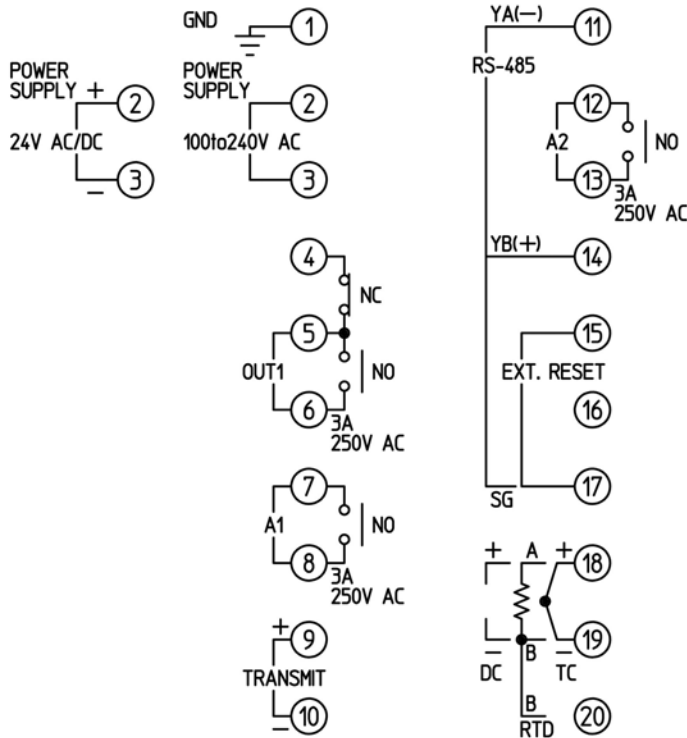

- OUT1 : Limit control output
 - A1 : Alarm 1 (A1) output
 - TRANSMIT : Transmission output
 - EXT.RESET: External reset input
 - RS-485 : Serial communication (C5 option)
 - DC : DC current, DC voltage input
 - TC : Thermocouple input
 - RTD : Resistance temperature detector input
- For DC current input, connect 50Ω shunt resistor between input terminals.**

(Fig. 4-1)

Notice

- The terminal block of the JCD-33A is designed to be wired from the left side. The lead wire must be inserted from the left side of the terminal, and fastened by the terminal screw.
- Use a thermocouple and compensating lead wire that correspond to the sensor input specification of this controller.
- Use the 3-wire RTD which corresponds to the input specification of this controller.
- This controller does not have built-in power switch, circuit breaker or fuse. Therefore, it is necessary to install them in the circuit near the external controller. (Recommended fuse: Time-lag fuse, rated voltage 250V AC, rated current 2A)
- For a 24V AC/DC power source, do not confuse polarity when using direct current (DC).
- For the OUT1 (Limit control output terminals 5-6), externally use a relay according to the capacity of the load to protect the built-in relay contact.
- When wiring, keep input wires (thermocouple, RTD, etc.) away from AC sources or load wires to avoid external interference.
- Do not apply a commercial power source to the sensor connected to the input terminal nor allow the power source to come into contact with the sensor.

Lead wire solderless terminal

Use a solderless terminal with an insulation sleeve in which an M3 screw fits as shown below. The torque is approximately 0.6N•m to 1.0N•m.

Solderless terminal	Manufacturer	Model	Tightening torque
Y type	Nichifu Terminal Industries CO.,LTD.	TMEV1.25Y-3	0.6N•m Max. 1.0N•m
	Japan Solderless Terminal MFG CO.,LTD.	VD1.25-B3A	
Round type	Nichifu Terminal Industries CO.,LTD.	TMEV1.25-3	
	Japan Solderless Terminal MFG CO.,LTD.	V1.25-3	

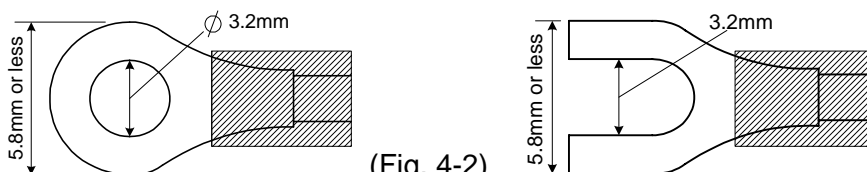

(Fig. 4-2)

5. Settings

5.1 Operation flowchart

Outline of operation procedure

Set Input type, Alarm (type, value, etc.) and SV (desired value), following the procedures below. Setting item numbers (1) to (7) are indicated on the flowchart.

[Step 1 Operation before run]	Turn the load circuit power OFF, and turn the power supply to the JCD-33A ON.
[Step 2 Auxiliary function setting mode 2]	Set Input type, Alarm type, etc. in the Setup mode. (1) Input type: Select an input type. Refer to "Input type (character indication) and range" on page 7. (2) A1 type: Select an alarm type. Refer to "Alarm type" on page 7. [If an alarm type except for "----" is selected, items (3) to (5) will be indicated and they can be set if necessary.] Note: If an alarm type is changed, the alarm set value becomes 0 (0.0). Therefore it is necessary to set it again. (3) A1 action Energized/Deenergized: Select Alarm 1 action Energized or Deenergized. (4) A1 hysteresis: Set A1 hysteresis. (5) A1 action delayed timer: Set A1 action delayed timer.
[Step 3 Main setting mode]	(6) SV: Set SV (desired value) in the Main setting mode. (7) A1 value: Set action point of A1 output in the Main setting mode.
[Step 4 Run]	Turn the load circuit power ON. Control action starts so as to keep the control target at the SV (Desired value).

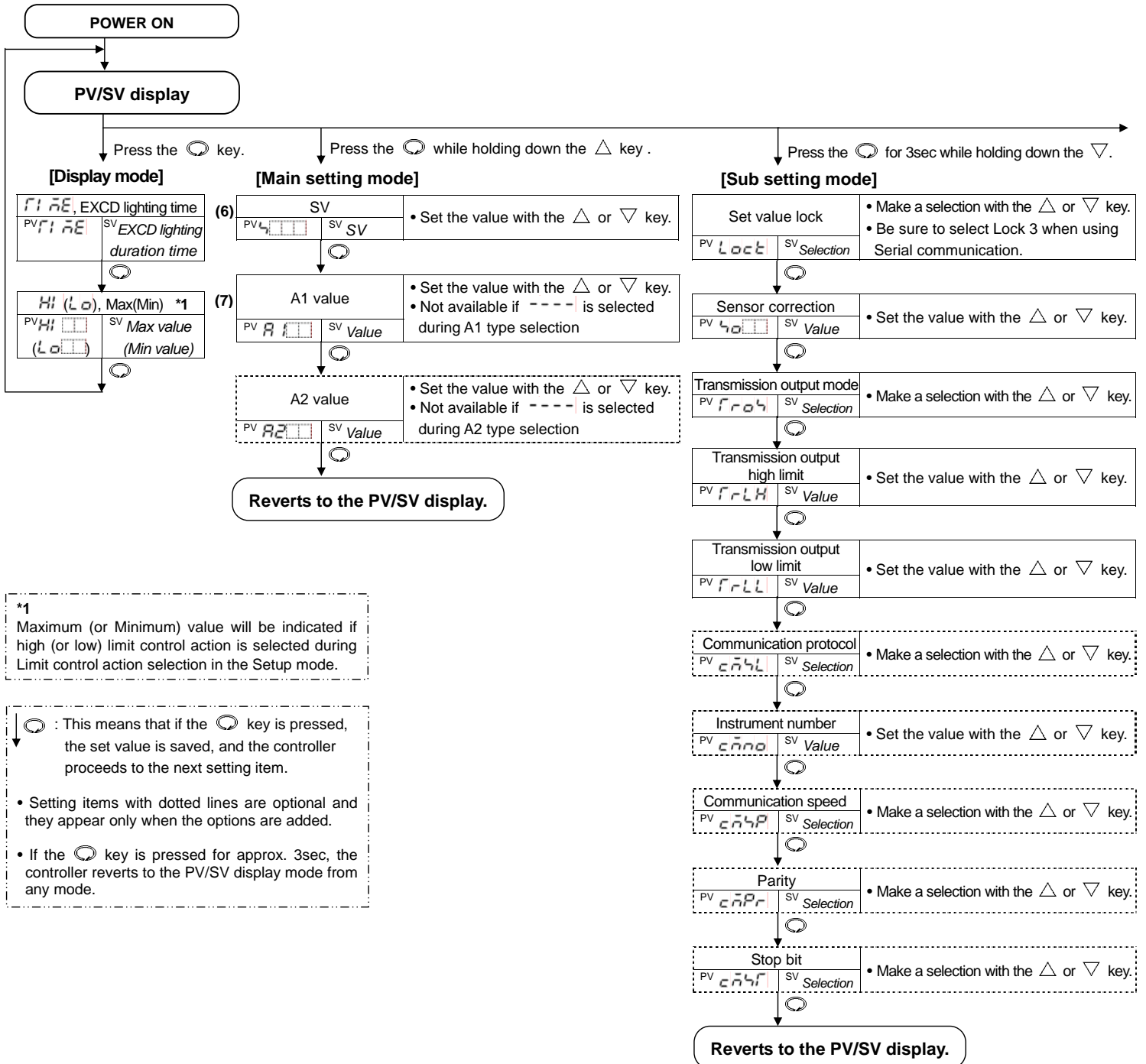

Input type (character indication) and range			
$t_{\square\square\square}C$: K	-200 to 1370°C	$t_{\square\square\square}F$: K	-320 to 2500°F
$t_{\square\square\square}C$:	-199.9 to 400.0°C	$t_{\square\square\square}F$:	-199.9 to 750.0°F
$J_{\square\square\square}C$: J	-200 to 1000°C	$J_{\square\square\square}F$: J	-320 to 1800°F
$r_{\square\square\square}C$: R	0 to 1760°C	$r_{\square\square\square}F$: R	0 to 3200°F
$s_{\square\square\square}C$: S	0 to 1760°C	$s_{\square\square\square}F$: S	0 to 3200°F
$b_{\square\square\square}C$: B	0 to 1820°C	$b_{\square\square\square}F$: B	0 to 3300°F
$E_{\square\square\square}C$: E	-200 to 800°C	$E_{\square\square\square}F$: E	-320 to 1500°F
$f_{\square\square\square}C$: T	-199.9 to 400.0°C	$f_{\square\square\square}F$: T	-199.9 to 750.0°F
$n_{\square\square\square}C$: N	-200 to 1300°C	$n_{\square\square\square}F$: N	-320 to 2300°F
$PL_{\square\square}C$: PL-II	0 to 1390°C	$PL_{\square\square}F$: PL-II	0 to 2500°F
$c_{\square\square\square}C$: C(W/Re5-26)	0 to 2315°C	$c_{\square\square\square}F$: C(W/Re5-26)	0 to 4200°F
$Pt_{\square\square}C$: Pt100	-199.9 to 850.0°C	$Pt_{\square\square}F$: Pt100	-199.9 to 999.9°F
$JPt_{\square\square}C$: JPt100	-199.9 to 500.0°C	$JPt_{\square\square}F$: JPt100	-199.9 to 900.0°F
$Pt_{\square\square}C$: Pt100	-200 to 850°C	$Pt_{\square\square}F$: Pt100	-300 to 1500°F
$JPt_{\square\square}C$: JPt100	-200 to 500°C	$JPt_{\square\square}F$: JPt100	-300 to 900°F
$420A$: 4 to 20mA DC	-1999 to 9999		
$020A$: 0 to 20mA DC	-1999 to 9999		
$01B$: 0 to 1V DC	-1999 to 9999		
$05B$: 0 to 5V DC	-1999 to 9999		
$15B$: 1 to 5V DC	-1999 to 9999		
$010B$: 1 to 10V DC	-1999 to 9999		

Alarm type	
$H_{\square\square\square}$ (High limit alarm)	: The alarm action is \pm deviation setting from the SV. The alarm is activated if the PV (process variable) reaches the high limit set value.
$L_{\square\square\square}$ (Low limit alarm)	: The alarm action is \pm deviation setting from the SV. The alarm is activated if the PV (process variable) goes under the low limit set value.
$HL_{\square\square}$ (High/Low limits alarm)	: Combines High limit and Low limit alarm actions. When PV (process variable) reaches high limit set value or goes under the low limit set value, the alarm is activated.
$\overline{H}L_{\square\square}$ (High/Low limit range alarm)	: When PV (process variable) is between the high limit set value and low limit set value, the alarm is activated. If PV exceeds the high limit set value or goes under the low limit set value, the alarm output is turned off.
$R_{\square\square}$ (Process high alarm)	} Within the scale range of the controller, alarm action points can be set at random and if the PV (process variable) reaches the randomly set action point, the alarm is activated.
$\overline{R}_{\square\square}$ (Process low alarm)	
$H_{\square\square}\overline{S}$ (High limit alarm with standby)	} When the power to the controller is turned on, even if the PV (process variable) enters the alarm action range, the alarm is not activated. Even if the PV enters the alarm action range due to SV change during running, the alarm is not activated, either. If the controller is allowed to keep running, once the input exceeds the alarm action point, the standby function will be released.
$L_{\square\square}\overline{S}$ (Low limit alarm with standby)	
$HL_{\square\square}\overline{S}$ (High/Low limits with standby)	

Press the \bigcirc for 3sec while holding down the Δ and ∇ .

[Setup mode]

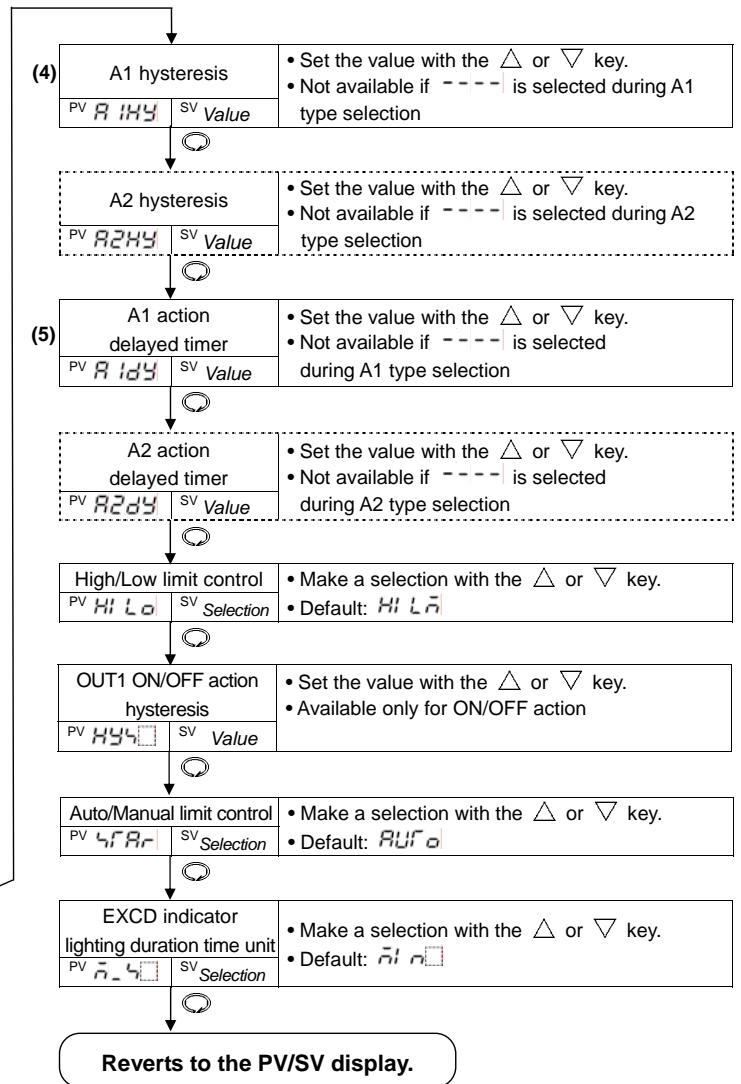
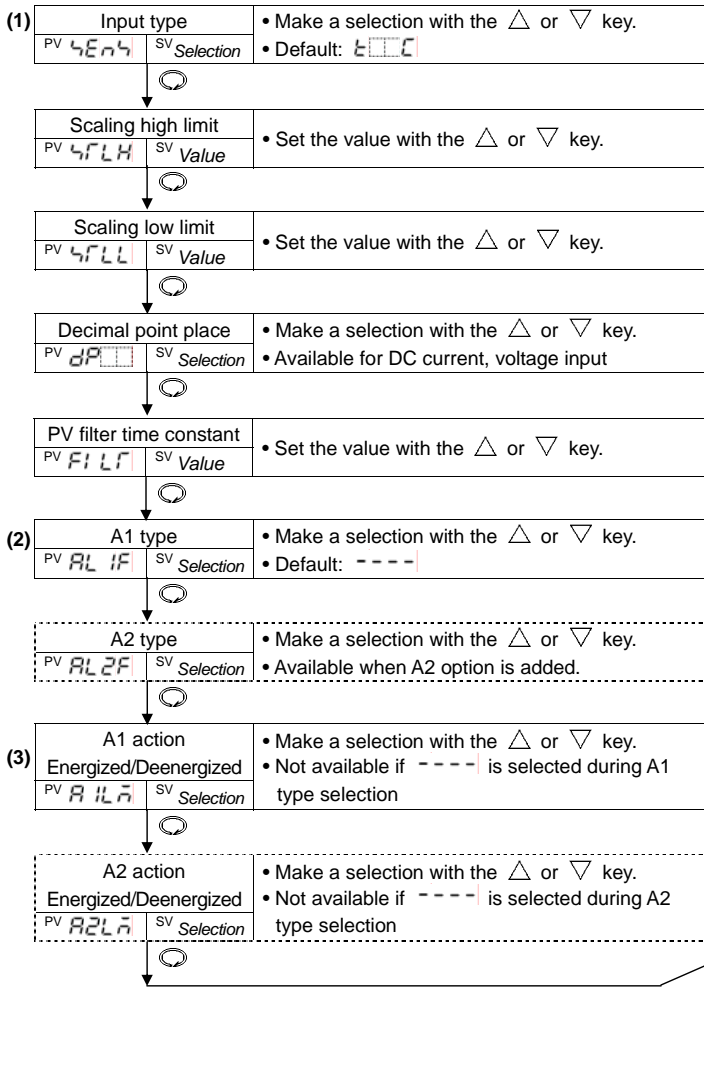

After the power is turned on, the input characters and temperature unit are indicated on the PV display, and the input range high limit value is indicated on the SV display for approximately 3 seconds.

(Table 5-1)

(If any other value is set during the scaling high limit setting, the set value is indicated on the SV display)

During this time, all outputs and the LED indicators are in OFF status.

Control will then start indicating the PV (process variable) on the PV display and SV (desired value) on the SV display.

(Table 5-1)





Input type	°C		°F	
	PV display	SV display	PV display	SV display
K	1000 4000	1370 4000	1000 4000	2500 7500
J	1000	1000	1000	1800
R	1760	1760	1760	3200
S	1760	1760	1760	3200
B	1820	1820	1820	3300
E	800	800	800	1500
T	1000	4000	1000	7500
N	1300	1300	1300	2300
PL-II	PL2C	1390	PL2F	2500
C (W/Re5-26)	2315	2315	2315	4200
Pt100	8500 850	8500 850	9999 1500	9999 1500
JPt100	5000 500	5000 500	9000 900	9000 900
4 to 20mA DC *	420A	Scaling high limit value		
0 to 20mA DC *	020A			
0 to 1V DC	0.1B			
0 to 5V DC	0.5B			
1 to 5V DC	1.5B			
0 to 10V DC	0.10B			

* Connect 50 Ω shunt resistor (sold separately) between input terminals.

5.2 Display mode

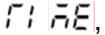
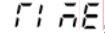

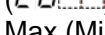
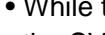
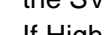
Selects an item to be indicated on the PV and SV display.



Every time the  key is pressed in the PV/SV display mode, the following indications are switched. When power is turned ON, the PV display indicates PV, and the SV display indicates SV.

Display	Name, Function, Setting range
 EXCD duration time	EXCD indicator lighting duration time indication <ul style="list-style-type: none"> The PV display indicates , and the SV display indicates “EXCD indicator lighting duration time”. Measurement range: 0:00 to 99:59 (The time unit can be selected during the “EXCD indicator lighting duration time unit selection” in the Setup mode.) Reverts to the default value (0:00 Hour:Minute/Minute:Second) if the  key is pressed or if the external reset input terminals 15 and 17 are shorted.
 () Max (Min) value	Hi (Lo) value indication <ul style="list-style-type: none"> While the EXCD indicator lights, the PV display indicates  or , and the SV display indicates the maximum or minimum value. If High limit control action (or Low limit control action) is selected during “Limit control action selection” in the Setup mode, the maximum value (or minimum value) is Indicated. Reverts to the current PV (input value) if the  key is pressed or if the external reset input terminals 15 and 17 are shorted.

5.3 Main setting mode

Sets SV, A1 and A2 value.

In the PV/SV display mode, press the  key while holding down the  key to proceed to the Main setting mode.

To set values, use the  or  key.

To register the value, use the  key.

Character	Name, Function, Setting range	Default value
SV	SV setting • Sets SV (desired value). • Setting range: Scaling low limit to Scaling high limit	0°C
A1	A1 value setting • Sets the action point of Alarm 1 (A1) output. • Not available if No alarm is selected during A1 type selection. • Setting range: Refer to (Table 5.3-1).	0°C
A2	A2 value setting • Sets the action point of Alarm 2 (A2) output. • Not available if No alarm is selected during A2 type selection. • Setting range: Refer to (Table 5.3-1).	0°C



(Table 5.3-1)



Alarm type	Setting range	
High limit alarm	– (Input span) to input span°C(F)	*1
Low limit alarm	– (Input span) to input span°C(F)	*1
High/Low limits alarm	0 to input span°C(F)	*1
High/Low limit range alarm	0 to input span°C(F)	*1
Process high alarm	Input range low limit value to input range high limit value	*2
Process low alarm	Input range low limit value to input range high limit value	*2
High limit alarm with standby	– (Input span) to input span°C(F)	*1
Low limit alarm with standby	– (Input span) to input span°C(F)	*1
High/Low limits alarm with standby	0 to input span°C(F)	*1

- When input has a decimal point, the negative low limit value is –199.9, and the positive high limit value is 999.9.
 - All alarm actions except process alarm are \pm deviation setting from the SV (desired value).
- *1: For DC input, the input span is the same as the scaling span.
*2: For DC input, input range low (or high) limit value is the same as scaling low (or high) limit value.

5.4 Sub setting mode

Sets Set value lock, Sensor correction, Communication parameters (when C5 option is added), etc.

In the PV/SV display mode, press the  key for approx. 3 seconds while holding down the  key to proceed to the Sub setting mode.

To set values, use the  or  key.



To register the value, use the  key.



Character	Name, Function, Setting range	Default value
Lock	Set value lock selection • Locks the set values to prevent setting errors. The setting item to be locked depends on the selection. • Selection range: ---- (Unlock): All set values can be changed. Loc 1 (Lock 1): None of the set values can be changed. Loc 2 (Lock 2): Only SV (desired value) can be changed. Loc 3 (Lock 3): All set values can be changed. However, do not change any setting item in the Setup mode. Changed values revert to their previous value after power is turned off because they are not saved in the non-volatile memory.	Unlock
SV	Sensor correction setting • Sets the correction value for the sensor. (Effective within the input rating value regardless of the sensor correction value) PV= Current actual temperature + Sensor correction value • Setting range: –100.0 to 100.0°C (°F)	0.0°C

<i>Tr04</i>	Transmission output mode selection <ul style="list-style-type: none"> • Selects PV or SV transmission. • Selection item: <i>PH</i>: PV transmission <i>4b</i>: SV transmission 	PV transmission
<i>TrLH</i>	Transmission output high limit setting <ul style="list-style-type: none"> • Sets Transmission output high limit value. • Setting range: Transmission output low limit value to Input range high limit value 	1370°C
<i>TrLL</i>	Transmission output low limit setting <ul style="list-style-type: none"> • Sets Transmission output low limit value. • Setting range: Input range low limit value to Transmission output high limit value. 	-200°C
<i>cñ4L</i>	Communication protocol selection <ul style="list-style-type: none"> • Selects the communication protocol. • Available only when the C5 option is applied. • Selection: <i>noñL</i>: Shinko protocol <i>ñodP</i>: Modbus ASCII mode <i>ñodr</i>: Modbus RTU mode 	Shinko protocol
<i>cñno</i>	Instrument number setting <ul style="list-style-type: none"> • Sets the instrument number individually to each instrument when communicating by connecting plural instruments in serial communication. • Available only when the C5 option is added. • Setting range: 0 to 95 	0
<i>cñ4P</i>	Communication speed selection <ul style="list-style-type: none"> • Selects a communication speed equal to that of the host computer. • Available only when the C5 option is added. • Selection: <i>24</i>: 2400bps <i>48</i>: 4800bps <i>96</i>: 9600bps <i>192</i>: 19200bps 	9600bps
<i>cñPr</i>	Parity selection <ul style="list-style-type: none"> • Selects the parity. • Not available if the C5 option is not added or if Shinko protocol is selected during the Communication protocol selection. • Selection: <i>noñE</i>: No parity <i>EñEñ</i>: Even parity <i>odñ</i>: Odd parity 	Even parity
<i>cñ4r</i>	Stop bit selection <ul style="list-style-type: none"> • Selects the stop bit. • Not available if the C5 option is not added or if Shinko protocol is selected during the Communication protocol selection. • Selection: <i>1</i>: 1 <i>2</i>: 2 	1











































































































5.5 Setup mode

Sets an input type, A1, A2 type, High/Low limit control action, etc.

In the PV/SV display mode, press the  key for approx. 3 seconds while holding down the  and  keys to proceed to the Setup mode.

To set values, use the  or  key.

To register the value, use the  key.

Character	Name, Function, Setting range	Default value																																																												
	Input type selection <ul style="list-style-type: none"> The input type can be selected from thermocouple (10 types), RTD (2 types), DC current (2 types) and DC voltage (4 types), and the unit °C/F can be selected as well. When changing the input from DC voltage to other inputs, remove the sensor connected to this controller first, then change for the input. If the input is changed with the sensor connected, the input circuit may break. 	K (-200 to 1370°C)																																																												
	<ul style="list-style-type: none"> Selection range: <table border="0"> <tr> <td>: K</td> <td>-200 to 1370°C</td> <td>: K</td> <td>-320 to 2500°F</td> </tr> <tr> <td>: K</td> <td>-199.9 to 400.0°C</td> <td>: K</td> <td>-199.9 to 750.0°F</td> </tr> <tr> <td>: J</td> <td>-200 to 1000°C</td> <td>: J</td> <td>-320 to 1800°F</td> </tr> <tr> <td>: R</td> <td>0 to 1760°C</td> <td>: R</td> <td>0 to 3200°F</td> </tr> <tr> <td>: S</td> <td>0 to 1760°C</td> <td>: S</td> <td>0 to 3200°F</td> </tr> <tr> <td>: B</td> <td>0 to 1820°C</td> <td>: B</td> <td>0 to 3300°F</td> </tr> <tr> <td>: E</td> <td>-200 to 800°C</td> <td>: E</td> <td>-320 to 1500°F</td> </tr> <tr> <td>: T</td> <td>-199.9 to 400.0°C</td> <td>: T</td> <td>-199.9 to 750.0°F</td> </tr> <tr> <td>: N</td> <td>-200 to 1300°C</td> <td>: N</td> <td>-320 to 2300°F</td> </tr> <tr> <td>: PL-II</td> <td>0 to 1390°C</td> <td>: PL-II</td> <td>0 to 2500°F</td> </tr> <tr> <td>: C(W/Re5-26)</td> <td>0 to 2315°C</td> <td>: C(W/Re5-26)</td> <td>0 to 4200°F</td> </tr> <tr> <td>: Pt100</td> <td>-199.9 to 850.0°C</td> <td>: Pt100</td> <td>-199.9 to 999.9°F</td> </tr> <tr> <td>: JPt100</td> <td>-199.9 to 500.0°C</td> <td>: JPt100</td> <td>-199.9 to 900.0°F</td> </tr> <tr> <td>: Pt100</td> <td>-200 to 850°C</td> <td>: Pt100</td> <td>-300 to 1500°F</td> </tr> <tr> <td>: JPt100</td> <td>-200 to 500°C</td> <td>: JPt100</td> <td>-300 to 900°F</td> </tr> </table>	 : K	-200 to 1370°C	 : K	-320 to 2500°F	 : K	-199.9 to 400.0°C	 : K	-199.9 to 750.0°F	 : J	-200 to 1000°C	 : J	-320 to 1800°F	 : R	0 to 1760°C	 : R	0 to 3200°F	 : S	0 to 1760°C	 : S	0 to 3200°F	 : B	0 to 1820°C	 : B	0 to 3300°F	 : E	-200 to 800°C	 : E	-320 to 1500°F	 : T	-199.9 to 400.0°C	 : T	-199.9 to 750.0°F	 : N	-200 to 1300°C	 : N	-320 to 2300°F	 : PL-II	0 to 1390°C	 : PL-II	0 to 2500°F	 : C(W/Re5-26)	0 to 2315°C	 : C(W/Re5-26)	0 to 4200°F	 : Pt100	-199.9 to 850.0°C	 : Pt100	-199.9 to 999.9°F	 : JPt100	-199.9 to 500.0°C	 : JPt100	-199.9 to 900.0°F	 : Pt100	-200 to 850°C	 : Pt100	-300 to 1500°F	 : JPt100	-200 to 500°C	 : JPt100	-300 to 900°F	
 : K	-200 to 1370°C	 : K	-320 to 2500°F																																																											
 : K	-199.9 to 400.0°C	 : K	-199.9 to 750.0°F																																																											
 : J	-200 to 1000°C	 : J	-320 to 1800°F																																																											
 : R	0 to 1760°C	 : R	0 to 3200°F																																																											
 : S	0 to 1760°C	 : S	0 to 3200°F																																																											
 : B	0 to 1820°C	 : B	0 to 3300°F																																																											
 : E	-200 to 800°C	 : E	-320 to 1500°F																																																											
 : T	-199.9 to 400.0°C	 : T	-199.9 to 750.0°F																																																											
 : N	-200 to 1300°C	 : N	-320 to 2300°F																																																											
 : PL-II	0 to 1390°C	 : PL-II	0 to 2500°F																																																											
 : C(W/Re5-26)	0 to 2315°C	 : C(W/Re5-26)	0 to 4200°F																																																											
 : Pt100	-199.9 to 850.0°C	 : Pt100	-199.9 to 999.9°F																																																											
 : JPt100	-199.9 to 500.0°C	 : JPt100	-199.9 to 900.0°F																																																											
 : Pt100	-200 to 850°C	 : Pt100	-300 to 1500°F																																																											
 : JPt100	-200 to 500°C	 : JPt100	-300 to 900°F																																																											
	Scaling high limit setting <ul style="list-style-type: none"> Sets scaling high limit value. Setting range: Scaling low limit value to input range high limit value 	1370°C																																																												
	Scaling low limit setting <ul style="list-style-type: none"> Sets scaling low limit value. Setting range: Input range low limit value to scaling high limit value 	-200°C																																																												
	Decimal point place selection <ul style="list-style-type: none"> Selects decimal point place. Available only for DC input Selection range: <table border="0"> <tr> <td></td> <td>No decimal point</td> </tr> <tr> <td></td> <td>1 digit after decimal point</td> </tr> <tr> <td></td> <td>2 digits after decimal point</td> </tr> <tr> <td></td> <td>3 digits after decimal point</td> </tr> </table>		No decimal point		1 digit after decimal point		2 digits after decimal point		3 digits after decimal point	No decimal point																																																				
	No decimal point																																																													
	1 digit after decimal point																																																													
	2 digits after decimal point																																																													
	3 digits after decimal point																																																													
	PV filter time constant setting <ul style="list-style-type: none"> Sets PV filter time constant. (If the value is set too large, it affects control result due to the delay of response) Setting range: 0.0 to 10.0 seconds 	0.0 seconds																																																												

AL IF	A1 type selection <ul style="list-style-type: none"> • Selects an action type for A1. • Selection range: <ul style="list-style-type: none"> ---- : No alarm action H--- : High limit alarm L--- : Low limit alarm HL-- : High/Low limits alarm UL d : High/Low limit range alarm AL-- : Process high alarm ~AL-- : Process low alarm H--- : High limit alarm with standby L--- : Low limit alarm with standby HL--- : High/Low limits alarm with standby 	No alarm action
AL 2F	A2 type selection <ul style="list-style-type: none"> • Selects an action type for A2. • Available only when A2 option is added • Selection range and default value are the same as those of A1 type selection. 	No alarm action
AL 1A	A1 action Energized/Deenergized selection <ul style="list-style-type: none"> • Selects Energized/Deenergized for A1. • Not available if No alarm action is selected during A1 type selection • Selection range: <ul style="list-style-type: none"> noAL : Energized ~EBL : Deenergized 	Energized
AL 2A	A2 action Energized/Deenergized selection <ul style="list-style-type: none"> • Selects Energized/Deenergized for A2. • Not available if A2 option is not added or if No alarm action is selected during A2 type selection • Selection range and default value are the same as those of A1 action Energized/Deenergized selection. 	Energized
AL 1H	A1 hysteresis setting <ul style="list-style-type: none"> • Sets A1 hysteresis. • Not available if No alarm action is selected during A1 type selection • Setting range: 0.1 to 100.0°C(F), or 1 to 1000 	1.0°C
AL 2H	A2 hysteresis setting <ul style="list-style-type: none"> • Sets A2 hysteresis. • Not available if A2 option is not added or if No alarm action is selected during A2 type selection • Setting range: 0.1 to 100.0°C(F), or 1 to 1000 	1.0°C
AL 1d	A1 action delayed timer setting <ul style="list-style-type: none"> • Sets A1 action delayed timer. When setting time has elapsed after the input enters the alarm output range, the alarm is activated. • Not available if No alarm action is selected during A1 type selection • Setting range: 0 to 9999 seconds 	0 seconds
AL 2d	A2 action delayed timer setting <ul style="list-style-type: none"> • Sets A2 action delayed timer. When setting time has elapsed after the input enters the alarm output range, the alarm is activated. • Not available if A2 option is not added or if No alarm action is selected during A2 type selection • Setting range: 0 to 9999 seconds 	0 seconds
HL Ld	High/Low limit control selection <ul style="list-style-type: none"> • Selects either High limit or Low limit control action. (Refer to Section 7.1, 7.2) • Selection item: <ul style="list-style-type: none"> HL Ld : High limit control Ld Ld : Low limit control 	High limit control
HY 4	OUT1 ON/OFF action hysteresis setting <ul style="list-style-type: none"> • Sets OUT1 (Limit control output) ON/OFF action hysteresis. • Setting range: 0.1 to 100.0°C(F), or 1 to 1000 	1.0°C

4FAR	Auto/Manual limit control selection • Selects either auto or manual limit control action. (Refer to Section 7.3) • Selection item: ARUF: Auto limit control ARNU: Manual limit control	Auto limit control
A4	EXCD indicator lighting duration time unit selection • Selects unit of "EXCD indicator lighting duration time". • Selection range: A1A: Hour:Minute 4EC: Minute:Second	Hour:Minute

Sensor correction function

This corrects the input value from the sensor. When a sensor cannot be set at a location where control is desired, the sensor measuring temperature may deviate from the temperature in the controlled location. When controlling with plural controllers, sometimes the measured temperatures (PV) do not concur due to differences in sensor accuracy or dispersion of load capacities.

In such a case, the control can be set at the desired temperature by adjusting the input value of sensors.

Energized/Deenergized

When A1/A2 Energized is selected, the A1/A2 output (between terminals 7-8, or 12-13) is conducted (ON) while the A1/A2 output indicator is lit.

The A1/A2 output is not conducted (OFF) while the A1/A2 output indicator is not lit.

When A1/A2 Deenergized is selected, the A1/A2 output (between terminals 7-8, or 12-13) is not conducted (OFF) while the A1/A2 output indicator is lit.

The A1/A2 output is conducted (ON) while the A1/A2 output indicator is not lit.

High limit alarm (when Energized is set) High limit alarm (when Deenergized is set)

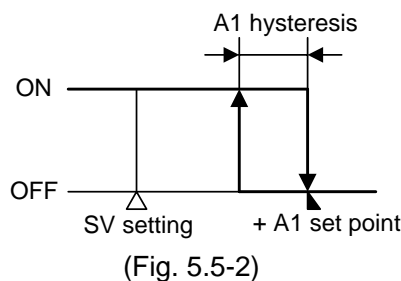
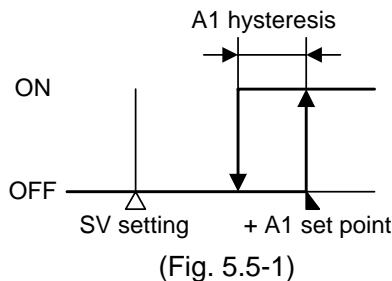

A1: Alarm 1
For Alarm 2(A2), read A2 for A1

6. Running

After the unit is mounted to the control panel and wiring is completed, operate the unit following the procedures below.

(1) Turn the power supply to the JCD-33A ON.

Turn the power supply to the JCD-33A ON.

- For approx. 3sec after the power is switched ON, the input characters and the temperature unit are indicated on the PV display and input range high limit value is indicated on the SV display. See (Table 5-1). (If any other value has been set during scaling high limit setting, the set value is indicated on the SV display.)

During this time, all outputs and LED indicators are in OFF status.

- After that, control starts indicating PV (process variable) on the PV display, and SV (desired value) on the SV display.

(2) Input each set value.

Input each set value, referring to "5. Settings".

(3) Turn the load circuit power ON.

Limit control action starts.

7. Action explanation

7.1 High limit control action (Fig. 7.1-1)

Auto limit control will be used for purposes of explanation of the High limit control action. (Refer to Section 7.3)

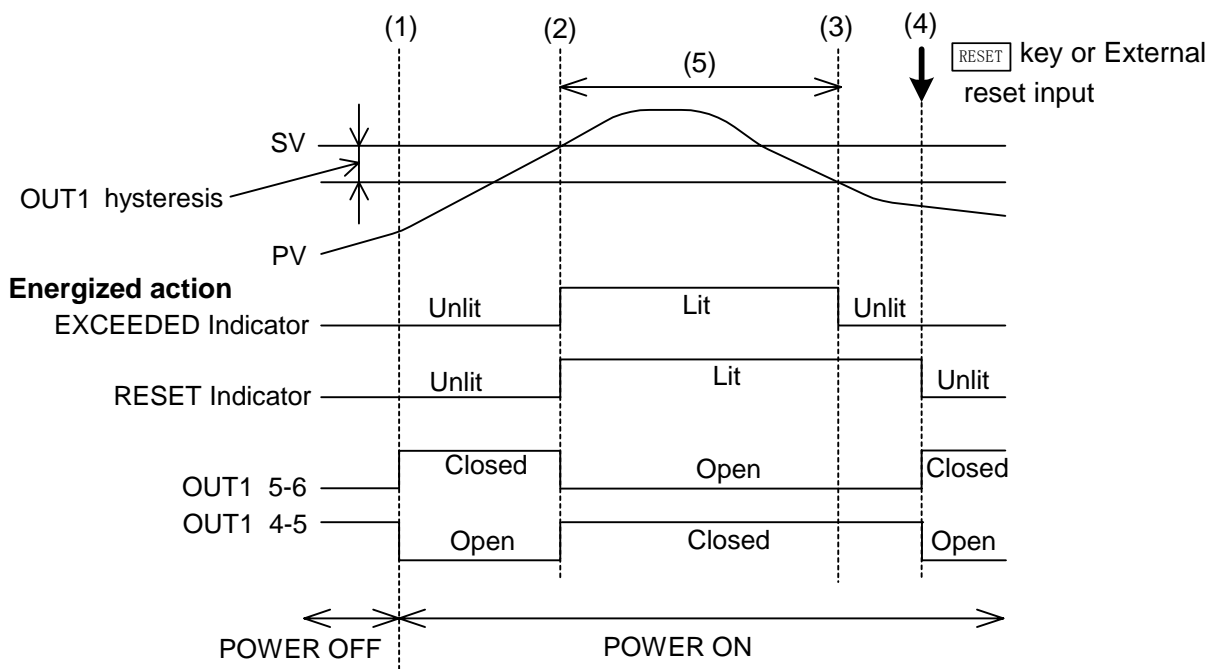

(Fig. 7.1-1)

- (1) Limit control action will initiate after power supply to the controller is turned on.
- (2) If PV exceeds SV, the EXCEEDED and RESET indicators light, and OUT1 (Limit control output terminals between 5-6) is turned OFF.
- (3) If PV drops below [SV-OUT1 hysteresis], the EXCEEDED indicator goes off. At this time, the RESET indicator is lit, and OUT1 (Limit control output terminals between 5-6) is in OFF status.
- (4) If the key is pressed, or if external reset input terminals between 15-17 are shorted, the RESET indicator goes off, OUT1 (Limit control output terminals between 5-6) is turned ON, and limit control action initiates again.
- (5) While the EXCEEDED indicator is lit, even if the key is pressed or even if external reset input terminals between 15-17 are shorted, limit control action does not initiate.

7.2 Low limit control action (Fig. 7.2-1)

Auto limit control will be used for purposes of explanation of the Low limit control action. (Refer to Section 7.3)

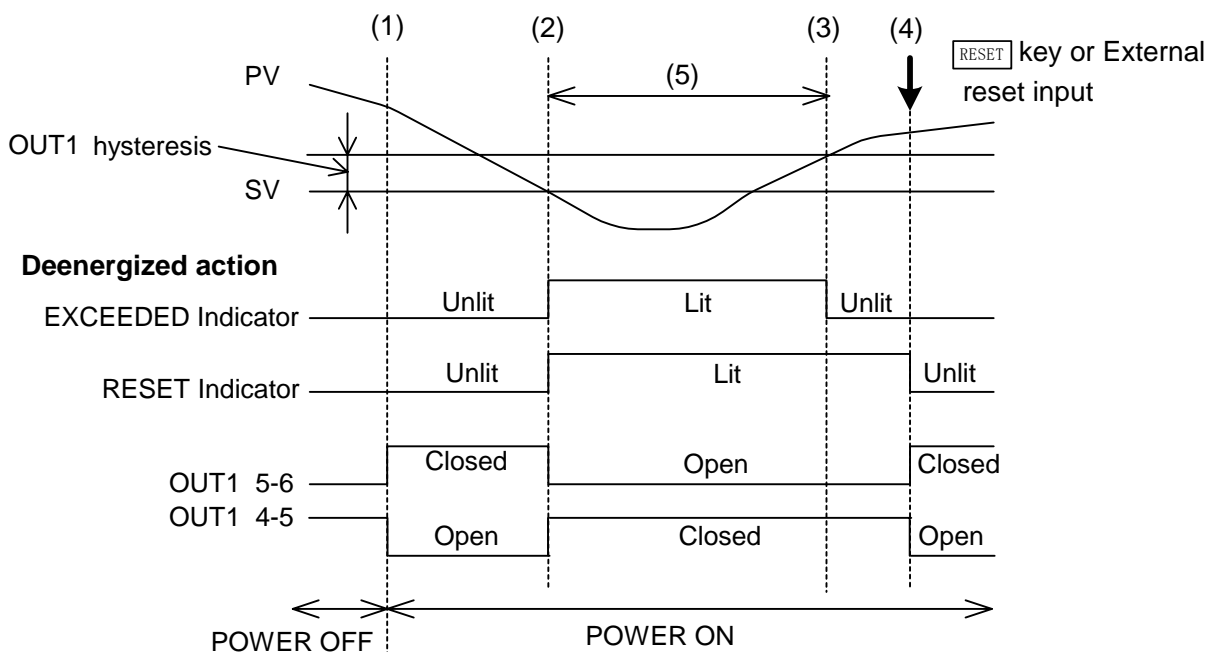

(Fig. 7.2-1)

- (1) Limit control action will initiate after power supply to the controller is turned on.
- (2) If PV drops below SV, the EXCEEDED and RESET indicators light, and OUT1 (Limit control output terminals between 5-6) is turned OFF.
- (3) If PV exceeds [SV+OUT1 hysteresis], the EXCEEDED indicator goes off.
At this time, the RESET indicator is lit, and OUT1 (Limit control output terminals between 5-6) is in OFF status.
- (4) If the **RESET** key is pressed, or if external reset input terminals between 15-17 are shorted, the RESET indicator goes off, OUT1 (Limit control output terminals between 5-6) is turned ON, and limit control action initiates again.
- (5) While the EXCEEDED indicator is lit, even if the **RESET** key is pressed or even if external reset input terminals between 15-17 are shorted, limit control action does not initiate.

7.3 Auto/Manual limit control

Auto limit control

When the power supply is turned on, or after the power is restored, the AUTO indicator lights, and limit control starts automatically even though the **RESET** key has not been pressed. However, limit control action does not initiate while the EXCEEDED indicator is lit.

Manual limit control

In the following cases, the RESET indicator lights, and it is necessary to reset the unit manually.

- When power is turned on
- When power is restored
- For high limit control action, when PV drops below the SV-Hysteresis after PV exceeded SV
For low limit control action, when PV exceeds the SV+Hysteresis after PV dropped below SV

Limit control action does not initiate while the EXCEEDED indicator is lit.

7.4 A1, A2 action

	High limit alarm	Low limit alarm	High/Low limits alarm
A1 action			
A1 output			
	High/Low limit range alarm	Process high alarm	Process low alarm
A1 action			
A1 output			
	High limit alarm with standby	Low limit alarm with standby	High/Low limits alarm with standby
A1 action			
A1 output			

- : A1 output terminals 7-8 (A2 output terminals 12-13) ON
- : A1 output terminals 7-8 (A2 output terminals 12-13) ON or OFF
- : A1 output terminals 7-8 (A2 output terminals 12-13) OFF
- : The standby functions.

- For A2, read A2 for A1.
- A1 indicator lights when output terminals between 7-8 are ON, and goes off when output terminals between 7-8 are OFF.
- A2 indicator lights when output terminals between 12-13 are ON, and goes off when output terminals between 12-13 are OFF.

8. Specifications

8.1 Standard specifications

- Mounting** : Flush
- Setting** : Input system using membrane sheet key
- Display** PV display : Red LED 4 digits, character size 18 x 8mm (H x W)
- SV display : Green LED 4 digits, character size 12.6 x 6mm (H x W)

Accuracy (Setting and Indication):

- Thermocouple : Within $\pm 0.2\%$ of each input span ± 1 digit, or within $\pm 2^\circ\text{C}$ (4°F), whichever is greater
- However R, S inputs, 0 to 200°C (400°F): Within $\pm 6^\circ\text{C}$ (12°F)
- B input, 0 to 300°C (600°F): Accuracy is not guaranteed.
- K, J, E, T, N inputs, less than 0°C (32°F): Within $\pm 0.4\%$ of input span ± 1 digit

- RTD : Within $\pm 0.1\%$ of each input span ± 1 digit, or within $\pm 1^\circ\text{C}$ (2°F), whichever is greater

- DC current : Within $\pm 0.2\%$ of each input span ± 1 digit
- DC voltage : Within $\pm 0.2\%$ of each input span ± 1 digit

Input sampling period : 0.25 seconds

- Input** Thermocouple : K, J, R, S, B, E, T, N, PL-II, C(W/Re5-26), External resistance, 100Ω or less (However, B input: External resistance, 40Ω or less)

- RTD : Pt100, JPt100, 3-wire system
Allowable input lead wire resistance (10Ω or less per wire)

- DC current : 0 to 20mA DC, 4 to 20mA DC
Input impedance: 50Ω
[Connect 50Ω shunt resistor (sold separately) between input terminals.]
Allowable input current: 50mA or less [when shunt resistor (sold separately) is used]

- DC voltage : 0 to 1V DC
Input impedance: $1\text{M}\Omega$ or more
Allowable input voltage: 5V or less
Allowable signal source resistance: $2\text{k}\Omega$ or less
- : 0 to 5V DC, 1 to 5V DC, 0 to 10V DC
Input impedance: $100\text{k}\Omega$ or more
Allowable input voltage: 15V or less
Allowable signal source resistance: 100Ω or less

OUT1 (Limit control output)

- Relay contact : 1a1b, Control capacity: 3A 250V AC (resistive load)
1A 250V AC (inductive load $\cos\phi=0.4$)
Electrical life: 100,000 times

A1 output

- Action : ON/OFF action
- Hysteresis : 0.1 to 100.0°C ($^\circ\text{F}$), 1 to 1000 (DC input) (Default: 1.0°C)
- Output : Relay contact 1a
Control capacity: 3A 250V AC (resistive load)
Electrical life: 100,000 times

Control action

High limit control action, Low limit control action

OUT1 (Limit control output) hysteresis: 0.1 to 100.0°C ($^\circ\text{F}$), or 1 to 1000 (DC input)

Circuit insulation configuration

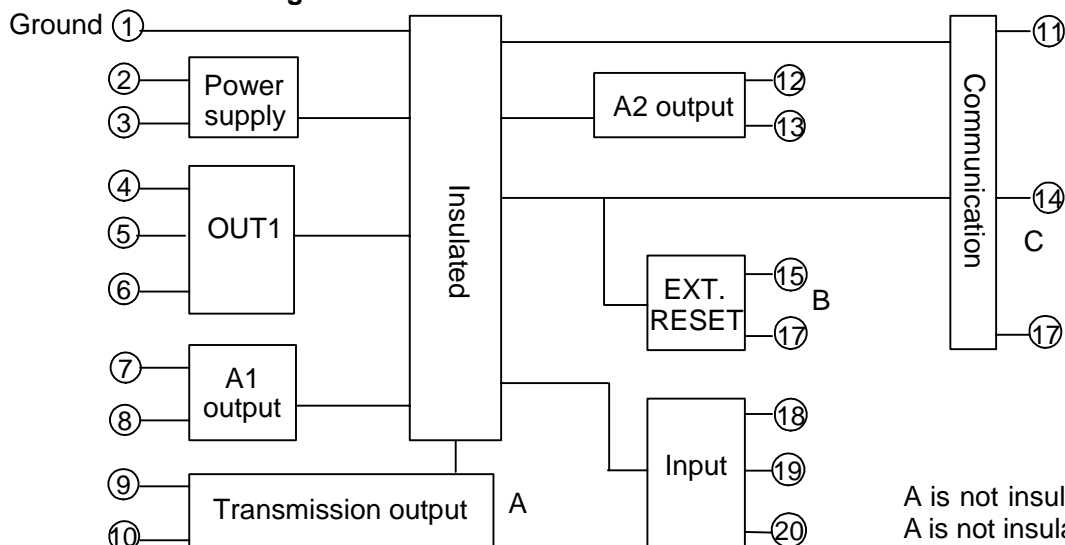

A is not insulated from B, and A is not insulated from C.

Insulation resistance : 10MΩ or more, at 500V DC
Dielectric strength : 1.5kV AC for 1 minute between input terminal and ground terminal
 1.5kV AC for 1 minute between input terminal and power terminal
 1.5kV AC for 1 minute between output terminal and ground terminal
 1.5kV AC for 1 minute between output terminal and power terminal
 1.5kV AC for 1 minute between power terminal and ground terminal

Supply voltage : 100 to 240V AC 50/60Hz, 24V AC/DC 50/60Hz

Allowable voltage fluctuation: 100 to 240V AC: 85 to 264V AC,
 24V AC/DC : 20 to 28V AC/DC

Power consumption : Approx. 8VA
Ambient temperature : 0 to 50°C (32 to 122°F)
Ambient humidity : 35 to 85%RH (no condensation)
Weight : Approx. 370g
External dimensions : 96 x 96 x 100mm (W x H x D)
Material : Flame-resistant resin (Case)
Color : Light gray (Case)

Attached functions : [Set value lock], [Sensor correction], [Auto/Manual limit control],
 [Input abnormality indication]

Thermocouple, RTD input:

If measured value exceeds Indication range high limit value, the PV display flashes “- - - -”.
 If measured value drops below Indication range low limit value, the PV display flashes “_ _ _ _”.
 If measured value goes out of the Control range, OUT1 (Limit control output) is turned OFF.

Input	Input range	Indication range	Control range
K, T	-199.9 to 400.0°C	-199.9 to 450.0°C	-205.0 to 450.0°C
	-199.9 to 750.0°F	-199.9 to 850.0°F	-209.0 to 850.0°F
Pt100	-199.9 to 850.0°C	-199.9 to 900.0°C	-210.0 to 900.0°C
	-200 to 850°C	-210 to 900°C	-210 to 900°C
	-199.9 to 999.9°F	-199.9 to 999.9°F	-211.0 to 1099.9°F
	-300 to 1500°F	-318 to 1600°F	-318 to 1600°F
JPt100	-199.9 to 500.0°C	-199.9 to 550.0°C	-206.0 to 550.0°C
	-200 to 500°C	-207 to 550°C	-207 to 550°C
	-199.9 to 900.0°F	-199.9 to 999.9°F	-211.0 to 999.9°F
	-300 to 900°F	-312 to 1000°F	-312 to 1000°F

Indication range and Control range for thermocouple inputs other than the above:
 Input range low limit value -50°C (100°F) to Input range high limit value +50°C (100°F)

Contents and Indication	Output status	
	(4)-(5)	(5)-(6)
Measured value has exceeded Indication range high limit value. “- - - -” flashes.	Closed	Open
Measured value has dropped below Indication range low limit value. “_ _ _ _” flashes.	Closed	Open

DC input:

Indication range: [Scaling low limit value–Scaling span x 1%] to [Scaling high limit value +Scaling span x 10%]
 However, “- - - -” or “_ _ _ _” flashes when a range of -1999 to 9999 is exceeded.

Control range: [Scaling low limit value–Scaling span x 1%] to [Scaling high limit value +Scaling span x 10%]

DC input disconnection: When DC input is disconnected, the PV display flashes “_ _ _ _” for 4 to 20mA DC and 1 to 5V DC inputs, and “- - - -” for 0 to 1V DC input. For 0 to 20mA DC, 0 to 5V DC and 0 to 10V DC inputs, the PV display indicates the value corresponding with 0mA or 0V input.

[Burnout]

When the thermocouple or RTD input is burnt out, OUT1 (Limit control output) is turned off, the PV becomes its maximum value and the PV display flashes “- - - -”.

[Self-diagnosis]

The CPU is monitored by a watchdog timer, and if an abnormal status is found on the CPU, the controller is switched to warm-up status.

[Automatic cold junction temperature compensation] (Only thermocouple input type)

This detects the temperature at the connecting terminal between the thermocouple and the instrument, and always maintains at the same status as when the reference junction is located at 0°C (32°F).

[Power failure countermeasure]

The setting data is backed up in the non-volatile IC memory.

[Warm-up indication]

After the power supply to the instrument is turned on, the PV display indicates input type, and the SV display indicates scaling high limit value for 3 seconds.

[Peak (or Bottom) value hold function]

While the EXCEEDED indicator is lit, the peak value is maintained during high limit action, or Bottom (the lowest) value is maintained during low limit action.

Present measured value will be initialized after reset using the RESET key or the external reset input function.

[EXCEEDED indicator lighting duration time]

EXCEEDED indicator lighting time can be measured and indicated by pressing the Mode () key in the PV/SV display mode.

Measurement range: 0:00 to 99:59 (Hour:Minute, Minute:Second)

Lighting time will be initialized to 0:00 after reset using the RESET key or the external reset input function.

[Transmission output]

Converting the value (PV transmission, SV transmission) to analog signal every 0.25 seconds, the value is outputted in current.

(Default: PV transmission)

Resolution : 1/8192

Current : 4 to 20mA DC (load resistance, maximum 550Ω)

Output accuracy: Within ±0.3% of each input span

Accessories: Screw type mounting brackets, 1 set
 Instruction manual, 1 copy
 Terminal cover, 2 pieces (when TC option is added)

8.2 Optional specifications**A2 output (Option code: A2)**

Action : ON/OFF action

Hysteresis: 0.1 to 100.0°C (°F), or 1 to 1000 (DC input) (Default: 1.0°C)

Output : Relay contact, 1a

Control capacity: 3A 250V AC (Resistive load)

Electrical life: 100,000 times

Serial communication (Option code: C5)

The following operations can be carried out from the external computer.

(1) Reading and setting of the SV and each set value

(2) Reading of the PV and action status

(3) Change of the functions

Cable length : Maximum communication distance 1.2km

Cable resistance: Within 50Ω (Terminator is not necessary or 120Ω or more on one side.)

Communication interface : EIA RS-485

Communication method : Half-duplex communication start-stop synchronization

Communication speed : 2400, 4800, 9600, 19200bps (Selectable by keypad) (Default: 9600bps)

Parity : Even, Odd and No parity (Selectable by keypad) (Default: Even parity)

Stop bit : 1, 2 (Selectable by keypad) (Default: 1)

Communication protocol : Shinko protocol, Modbus ASCII, Modbus RTU (Selectable by keypad)

Data format

Communication protocol	Shinko protocol	Modbus ASCII	Modbus RTU
Start bit	1	1	1
Data bit	7	7	8
Parity	Even	Selection (Even)	Selection(No parity)
Stop bit	1	Selection (1)	Selection (1)

Data bit is automatically selected upon selecting the communication protocol. (): Basic set value

Number of units connectable: Maximum 31 units to 1 host computer

Communication error detection: Double detection by parity and checksum





Terminal cover (Option code: TC): Electrical shock protection terminal cover

Color Black (Option code: BK): Front panel frame and Case: Black

9. Troubleshooting

If any malfunctions occur, refer to the following items after checking the power supply to the controller.

9.1 Indication

Problem	Presumed cause and solution
<p>“FL EE” is indicated on the PV display.</p>	<ul style="list-style-type: none"> The controller is in the EXCEEDED indicator lighting duration time mode. Press the  key twice to revert to the PV/SV display.
<p>“Hi ” or “Lo ” is indicated on the PV display.</p>	<ul style="list-style-type: none"> Maximum or Minimum value is indicated. Press the  key once to revert to the PV/SV display.
<p>“---” is flashing on the PV display.</p>	<ul style="list-style-type: none"> Burnout of thermocouple, RTD or disconnection of DC voltage (0 to 1V DC) Change each sensor. How to check whether the sensor is burnt out [Thermocouple] If the input terminals of the instrument are shorted, and if a value around room temperature is indicated, the instrument is likely to be operating normally, however, the sensor may be burnt out. [RTD] If approx. 100Ω of resistance is connected to the input terminals between A-B of the instrument and between B-B is shorted, and if a value around 0°C (32°F) is indicated, the instrument is likely to be operating normally, however, the sensor may be burnt out. [DC voltage (0 to 1V DC)] If the input terminals of the instrument are shorted, and if a scaling low limit value is indicated, the instrument is likely to be operating normally, however, the signal wire may be disconnected. Check whether the input terminals of thermocouple, RTD or DC voltage (0 to 1V DC) are securely mounted to the instrument input terminals. Connect the sensor terminals to the instrument input terminals securely.
<p>“---” is flashing on the PV display.</p>	<ul style="list-style-type: none"> Check whether input signal wire for DC voltage (1 to 5V DC) or DC current (4 to 20mA DC) is disconnected. How to check whether the input signal wire is disconnected [DC voltage (1 to 5V DC)] If the input to the input terminals of the instrument is 1V DC and if a scaling low limit value is indicated, the instrument is likely to be operating normally, however, the signal wire may be disconnected. [DC current (4 to 20mA DC)] If the input to the input terminals of the instrument is 4mA DC and if a scaling low limit value is indicated, the instrument is likely to be operating normally, however, the signal wire may be disconnected. Check whether input signal wire for DC voltage (1 to 5V DC) or DC current (4 to 20mA DC) is securely connected to the instrument input terminals. Check if polarity of thermocouple or compensating lead wire is correct. Check whether codes (A, B, B) of RTD agree with the instrument terminals.
<p>The indication of PV display is abnormal or unstable.</p>	<ul style="list-style-type: none"> Check whether sensor input or temperature unit (°C or °F) is correct. Select the sensor input and temperature unit (°C or °F) properly. Sensor correcting value is unsuitable. Set it to a suitable value. Check whether the specification of the sensor is correct. AC may be leaking into the sensor circuit. Use an ungrounded type sensor. There may be equipment that interferes with or makes noise near the controller. Keep equipment that interferes with or makes noise away from the controller.

<p>The PV display keeps indicating the value which was set during Scaling low limit setting.</p>	<ul style="list-style-type: none"> • Check whether the input signal wire for DC voltage (0 to 5V DC, 0 to 10V DC) and DC current (0 to 20mA DC) is disconnected. <p>How to check whether the input signal wire is disconnected [DC voltage (0 to 5V DC, 0 to 10V DC)] If the input to the input terminals of the instrument is 1V DC and if the value corresponding to 1V DC is indicated, the instrument is likely to be operating normally, however, the signal wire may be disconnected.</p> <p>[DC current (0 to 20mA DC)] If the input to the input terminals of the instrument is 1mA DC and if the value corresponding to 1mA DC is indicated, the instrument is likely to be operating normally, however, the signal wire may be disconnected.</p> <ul style="list-style-type: none"> • Check whether the input lead wire terminals for DC voltage (0 to 5V DC, 0 to 10V DC) or DC current (0 to 20mA DC) are securely mounted to the instrument input terminals.
<p>The PV display is indicating "Err i".</p>	<ul style="list-style-type: none"> • Internal memory is defective. Contact our agency or us.

9.2 Key operation

Problem	Presumed cause and solution
<ul style="list-style-type: none"> • Unable to set the SV, A1 value, etc. • The values do not change by \triangle or ∇ key. 	<ul style="list-style-type: none"> • Set value lock (Lock 1 or Lock 2) is selected. Release the lock.
<p>The setting indication does not change within the input range even if the \triangle or ∇ key is pressed, and new values are unable to be set.</p>	<ul style="list-style-type: none"> • Scaling high or low limit value in the Setup mode may be set at the point where the value does not change. Set it to a suitable value while in the Setup mode.

9.3 Control

Problem	Presumed cause and solution
<p>Temperature does not rise.</p>	<ul style="list-style-type: none"> • Sensor is out of order. Replace the sensor. • Check whether the Sensor or control output terminals are securely mounted to the instrument input terminals. Ensure that the sensor or control output terminals are mounted to the instrument input terminals securely. • Check whether the wiring of sensor or control output terminals is correct.

- For all other malfunctions, please contact our main office or dealers.

SHINKO TECHNOS CO.,LTD. OVERSEAS DIVISION

Reg. Office: 2-5-1, Senbahigashi, Minoo, Osaka, Japan

URL : <http://www.shinko-technos.co.jp>

E-mail : overseas@shinko-technos.co.jp

Tel : 81-72-727-6100

Fax: 81-72-727-7006