

# A world-wide success story

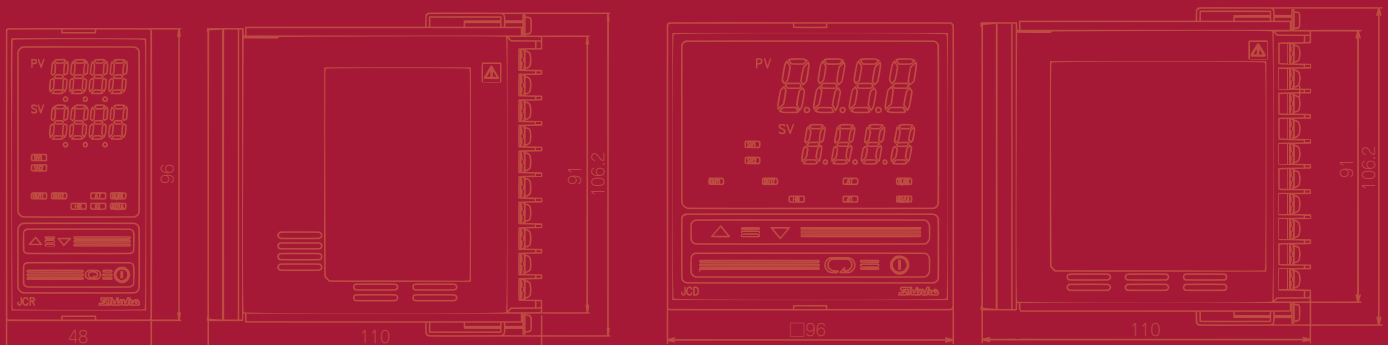

3 types of controller selectable based on installation space  
**2-point SV externally selectable**



**CE, UL conformity**



## Model name

J C □ -33A-□/□ □, □□□			
Series name	S	W48 x H48 x D95mm	
	R	W48 x H96 x D98.5mm	
	D	W96 x H96 x D98.5mm	
Control output (OUT1)	R	Relay contact	
	S	Non-contact voltage (for SSR drive)	
	A	DC current	
Input	M	Multi-input	
Supply voltage		100 to 240V AC	
	1	24V AC/DC	
Option	A 2	Alarm 2 (A2)	
	W ( 5A)	Rated current: 5A	Heater burnout alarm (*2)
	W (10A)	Rated current: 10A	
	W (20A)	Rated current: 20A	
	W (50A)	Rated current: 50A	
	D R (*3)	Control output (OUT2) (Heating/Cooling control output)	
	D S (*3)		
	D A (*3)		
	D T (*4)		
	C 5	Serial communication (Based on EIA RS-485) (*5)	
	S M	SV1/SV2 external selection (*4)	
	L A	Loop break alarm	
	P 2 4	Insulated power supply output (*3)	
	T C	Terminal cover	
B K	Color Black		

(\*1): Standard voltage is 100 to 240V AC.

Only when ordering 24V AC/DC, enter [1] after the input code.

(\*2): For DC current output type, [W] option cannot be added.

(\*3): Can be added only to the JCR-33A and JCD-33A.

(\*4): Can be added only to the JCS-33A.

(\*5): When [C5] option is added to the JCR-33A or JCD-33A, SV1/SV2 external selection cannot be used.

### [Option combination for the JCS-33A]

	A 2	W	D T	C 5	S M	L A	T C	B K
Combination 1	○	○	×	○	×	○	○	○
Combination 2	×	×	○	○	×	×	○	○
Combination 3	○	○	×	×	○	○	○	○
Combination 4	×	×	○	×	○	×	○	○

### [Option combination for the JCR-33A and JCD-33A]

	A 2	W	D □	C 5	L A	P 2 4	T C	B K
Combination 1	○	○	×	○	○	×	○	○
Combination 2	○	×	○	○	○	×	○	○
Combination 3	×	○	○	○	×	×	○	○
Combination 4	○	×	×	○	○	○	○	○

## Rated scale

Input type	Scale		
Thermocouple	K	-200 to 1370 °C	-320 to 2500 °F
		-199.9 to 400.0 °C	-199.9 to 750.0 °F
	J	-200 to 1000 °C	-320 to 1800 °F
	R	0 to 1760 °C	0 to 3200 °F
	S	0 to 1760 °C	0 to 3200 °F
	B	0 to 1820 °C	0 to 3300 °F
	E	-200 to 800 °C	-320 to 1500 °F
	T	-199.9 to 400.0 °C	-199.9 to 750.0 °F
	N	-200 to 1300 °C	-320 to 2300 °F
	PL-II	0 to 1390 °C	0 to 2500 °F
C (W/Re5-26)	0 to 2315 °C	0 to 4200 °F	

Input type	Scale		
RTD	Pt100	-200 to 850 °C	-300 to 1500 °F
		-199.9 to 850.0 °C	-199.9 to 999.9 °F
	JPt100	-200 to 500 °C	-300 to 900 °F
DC current (*1)	4 to 20mA DC	-1999 to 9999, -199.9 to 999.9	
	0 to 20mA DC		
DC voltage	0 to 1V DC	-19.99 to 99.99, -1.999 to 9.999 (*2)	
	0 to 10V DC		
	1 to 5V DC		
	0 to 5V DC		

(\*1): For DC current input, connect 50Ω shunt resistor (sold separately) externally.

(\*2): For DC current input and DC voltage input, scaling and decimal point place are changeable.

## Standard specifications

Display	JCS-33A: PV [Red 4 digits, Character size: 10.2 x 4.9mm (H x W)], SV [Green 4 digits, Character size: 8.8 x 4.9mm (H x W)] JCR-33A: PV [Red 4 digits, Character size: 11.2 x 5.4mm (H x W)], SV [Green 4 digits, Character size: 11.2 x 5.4mm (H x W)] JCD-33A: PV [Red 4 digits, Character size: 18 x 8mm (H x W)], SV [Green 4 digits, Character size: 12.6 x 6mm (H x W)]
Input	Thermocouple : K, J, R, S, B, E, T, N, PL-II, C (W/Re5-26) External resistance: 100Ω or less (However, for B input: 40Ω or less) RTD : Pt100, JPt100 3-wire system (Allowable input lead wire resistance per wire: 10Ω or less) DC current : 0 to 20mA DC, 4 to 20mA DC Input impedance: 50Ω (Connect shunt resistor 50Ω between input terminals.) Allowable input current: 50mA or less (When shunt resistor 50Ω is used) DC voltage : 0 to 1V DC Input impedance: 1MΩ or more Allowable input voltage: 5V or less Allowable signal source resistance: 2kΩ or less 0 to 5V DC, 1 to 5V DC, 0 to 10V DC Input impedance: 100kΩ or more Allowable input voltage: 15V or less Allowable signal source resistance: 100Ω or less
Accuracy (Setting, Indication)	Thermocouple : Within ±0.2% of each input span ±1 digit or ±2°C(4°F) whichever is greater However, R or S input, 0 to 200°C(0 to 400°F) : Within ±6°C(12°F) B input, 0 to 300°C(0 to 600°F) : Accuracy is not guaranteed. K, J, E, T, and N input, less than 0°C(32°F) : Within ±0.4% of each input span ±1 digit RTD : Within ±0.1% of each input span ±1 digit or ±1°C(2°F) whichever is greater DC current, DC voltage : Within ±0.2% of each input span ±1 digit
Input sampling period	250ms
Control output (OUT 1)	Relay contact : 1a1b (JCS-33A: 1a), 3A 250V AC (Resistive load), 1A 250V AC (Inductive load cos φ=0.4), Electric life: 100,000 cycles Non-contact voltage : 12V DC Max. 40mA (Short circuit protected) DC current : 4 to 20mA DC Load resistance: Max. 550Ω
Control action	Actions mentioned below can be selected by keypad. [Default: PID] PID (with auto-tuning function), PI, PD (with auto reset function), P (with auto reset function), ON/OFF OUT1 proportional band (P) : Thermocouple: 0 to 1000°C(0 to 2000°F) (ON/OFF action when set to 0) RTD: 0.0 to 999.9°C(0.0 to 999.9°F) (ON/OFF action when set to 0.0) DC current and DC voltage: 0.0 to 100.0% (ON/OFF action when set to 0.0) Integral time (I) : 0 to 1000 seconds (OFF when set to 0) Derivative time (D) : 0 to 300 seconds (OFF when set to 0) OUT1 proportional cycle : 1 to 120 seconds (Not available for DC current output type) OUT1 ARW : 0 to 100% Hysteresis : Thermocouple and RTD: 0.1 to 100.0°C(°F) DC current and DC voltage: 1 to 1000 (The placement of the decimal point follows the selection.) OUT1 output limit : -5 to 105%
Alarm 1 (A1)	Alarm action and Energized/De-energized can be selected by keypad. [Default: No alarm] • No alarm • High limit alarm (Deviation setting) Setting range: -(Input span) to Input span • Low limit alarm (Deviation setting) Setting range: -(Input span) to Input span • High/Low limits alarm (Deviation setting) Setting range: 0 to Input span • High/Low limit range alarm (Deviation setting) Setting range: 0 to Input span • Process high alarm Setting range: Input range low limit value to Input range high limit value • Process low alarm Setting range: Input range low limit value to Input range high limit value • High limit alarm w/standby (Deviation setting) Setting range: -(Input span) to Input span • Low limit alarm w/standby (Deviation setting) Setting range: -(Input span) to Input span • High/Low limits alarm w/standby (Deviation setting) Setting range: 0 to Input span

Alarm 1 (A1)	<p>When input uses a decimal point, the negative low limit value is -199.9 and the positive high limit value is 999.9.  When input is DC current or DC voltage, input span is scaling span.  When input is DC current or DC voltage, input range low (or high) limit value is scaling low (or high) limit value.  Setting accuracy : The same as the indicating accuracy  Action : ON/OFF action  Hysteresis : Thermocouple and RTD: 0.1 to 100.0°C(°F)  DC current and DC voltage: 1 to 1000 (The placement of the decimal point follows the selection.)  Output : Relay contact 1a, 3A 250V AC (Resistive load), Electric life: 100,000 cycles</p>
SV1/SV2 external selection	Selects SV1 or SV2 from the external contact. (For JCS-33A, [SM] option needs to be added.) SV1: Contact open between terminals 14 and 17 SV2: Contact closed between terminals 14 and 17
Supply voltage	100 to 240V AC 50/60Hz, 24V AC/DC 50/60Hz Allowable voltage fluctuation range: 85 to 264V AC, 20 to 28V AC/DC
Power consumption	Approx. 8VA
Insulation resistance	When control output (OUT1) is Non-contact voltage or DC current output with [DS or DA] option is added, insulation test between Control output (OUT1) terminal and Heater burnout alarm output terminal, between Control output (OUT1) terminal and Control output (OUT2) terminal, between Control output (OUT1) terminal and Insulated power output terminal must not be carried out. When control output (OUT1) is Non-contact voltage or DC current output, insulation test between Control output (OUT1) and SV1/SV2 external switch terminal, between control output (OUT1) and communication terminal must not be carried out. When control output (OUT2) is Non-contact voltage or DC current output, insulation test between Control output 2 (OUT2) and SV1/SV2 external switch terminal, between control output (OUT2) and communication terminal must not be carried out. Other combinations: 10MΩ or more, at 500V DC
Dielectric strength	1.5kV AC for 1min between input terminal and ground terminal, between input terminal and power terminal 1.5kV AC for 1min between power terminal and ground terminal 1.5kV AC for 1min between output terminal and ground terminal, between output terminal and power terminal
Environment	Ambient temperature: 0 to 50°C Ambient humidity: 35 to 85%RH (Non-condensing) Drip-proof/Dust-proof IP66 for the front panel
Safety standard	UL: Power input rating 100 to 240V AC, 24V AC/DC File No. E159038
Case (Material, Color)	Material: Flame-resistant resin Color: Light gray
Mounting	Screw type mounting brackets. (Mountable panel thickness: 1 to 8mm)
Setting	Sheet key input
External dimensions	JCS-33A: W48 x H48 x D95mm, JCR-33A: W48 x H96 x D98.5mm, JCD-33A: W96 x H96 x D98.5mm
Weight	JCS-33A (Approx. 200g), JCR-33A (Approx. 250g), JCD-33A (Approx. 370g)
Attached functions	Sensor correction, Set value LOCK, Power failure countermeasure, Self-diagnosis, Automatic cold junction temperature compensation (Only for thermocouple), Sensor burnout alarm, Input burnout, Warm-up indication, Auto/Manual control selection

## ■ Options

[Select options according to your needs. When ordering, designate the Option code to be added.]

JCS-33A has Event output which involves Alarm 2 (A2), Heater burnout alarm (W), Control output (OUT 2) and Loop break alarm (LA) output.

Alarm 2 (A2) [A2]	When this option is added, 1 alarm point is added. Specifications are the same as those of Alarm1 (A1).
Heater burnout alarm [W]	<p>Watches the heater current with CT (current transformer), and detects the burnout.  Heater rated current must be selected from 5A, 10A, 20A and 50A.  Setting accuracy : Within ±5% of heater rated current  Output : Relay contact 1a 3A 250V AC (Resistive load), Electric life: 100,000 cycles  Accessories : CT (for single phase: 1 piece)  Upon returning to set limits, the alarm will stop.</p>
Control output (OUT2) (Heating/Cooling control) [DR, DS, DA, DT]	<p>If this option is applied, control output 2 is added and enables Heating/Cooling control.  Heating control action (Heating side): The same as control output (OUT1)  Cooling control action (Cooling side):  Proportional band (P) : 0.0 to 10.0 times the control output (OUT1) proportional band (ON/OFF action when set to 0.0)  Integral time (I) : The same as that of the control output (OUT1).  Derivative time (D) : The same as that of the control output (OUT1).  Proportional cycle : 1 to 120 seconds (Not available for DC current output type)  Overlap band/Dead band : Thermocouple and RTD: -100.0 to 100.0°C(°F)  DC current and DC voltage: -1000 to 1000 (The placement of the decimal point follows the selection.)  Hysteresis : 0.1 to 100.0°C(°F)  Control output  • Relay contact (DR) : 1a, 3A 250V AC (Resistive load), 1A 250V AC (Inductive load cos φ=0.4), Electric life: 100,000 cycles  • Non-contact voltage (DS) : 12% V DC Max. 40mA (Short circuit protected)  • DC current (DA) : 4 to 20mA DC Load resistance: Max. 550Ω  • Non-contact relay (DT) : 0.3A 250V AC (Resistive load)  Cooling action mode (This must be selected by key operation from below.)  • Air cooling (Linear characteristic)  • Oil cooling (1.5<sup>th</sup> Power of the linear characteristic)  • Water cooling (2<sup>nd</sup> Power of the linear characteristic)</p>
Serial communication [C5]	<p>Various setting status changing, reading and setting of the JC□-33A can be performed from an external computer.  By combining Shinko programmable controller (SVTC option added) with JC□-33A (C5 option added), it is possible to transmit the SV (set value) of the programmable controller digitally to the JC□-33A  Communication interface : EIA, RS-485  Communication method : Half-duplex communication  Synchronization method : Start-stop synchronization  Communication speed : (2400/4800/9600/19200bps) Selectable by keypad  Parity : (Even/ Odd/ No parity) Selectable by keypad  Stop bit : (1 or 2) Selectable by keypad  Communication protocol : Based on Shinko standard protocol or Modbus (Selectable by keypad)  (When Modbus is selected, RTU mode or ASCII mode can be selected by keypad.)  Number of connectable units : A maximum of 31 units per host computer  Communication error detection : Parity check and Checksum</p>
SV1/SV2 external selection [SM]	SV1 and SV2 can be changed by external contact. (Can be added only to the JCS-33A.) SV1: Contact open between terminals 13 and 14 SV2: Contact closed between terminals 13 and 14
Loop break alarm [LA]	<p>This option enables Heater burnout, Sensor burnout and actuator trouble to be detected.  Loop break alarm time : 0 to 200 minutes  Loop break alarm action span : Thermocouple and RTD: 0 to 150°C(°F), 0.0 to 150.0°C(°F)  DC current and DC voltage: 0 to 1500  Output : Relay contact 1a, 3A 250V AC (Resistive load), Electric life: 100,000 cycles</p>
Insulated power output [P24]	<p>When this option is added, 24V DC is outputted from the terminal 9 to 10 of JCD-33A and JCR-33A and can be the power source of 2-wire transmitter.  Output voltage : 24±3V DC (When load current is 30mA.)  Ripple voltage : 200mV (When load current is 30mA.)  Maximum load current: 30mA</p>
Terminal cover [TC]	Electrical shock protection cover
Color Black [BK]	Be sure to use this terminal cover by adding this option if operator may touch the back of the controller while running the controller. Case and base: Black.

## External dimensions (Scale: mm)

### JCS-33A

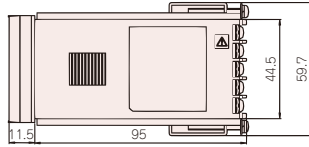
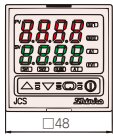

### JCR-33A

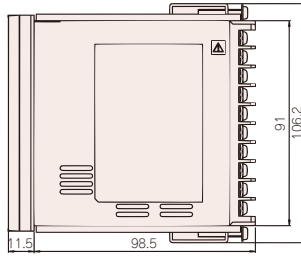
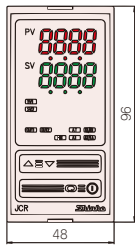

### JCD-33A

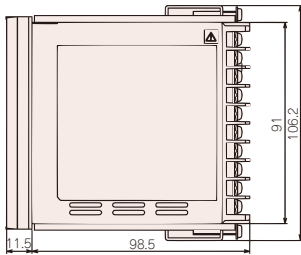
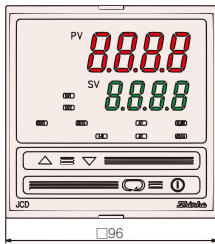

## Panel cutout (Scale: mm)

### JCS-33A

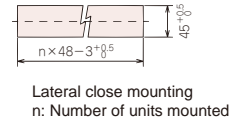
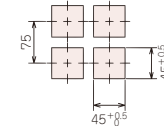

Lateral close mounting  
n: Number of units mounted

### JCR-33A

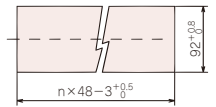
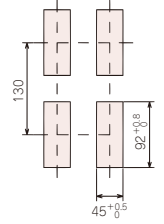

Lateral close mounting  
n: Number of units mounted

### JCD-33A

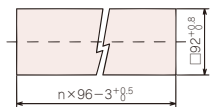
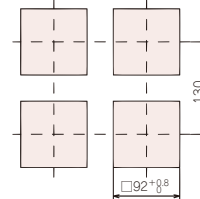

Lateral close mounting  
n: Number of units mounted

## Caution

If lateral close mounting is used for the controller, Drip-proof/Dust-proof IP66 may be Compromised, and all warranties will be invalidated.

## Terminal arrangement

### JCS-33A

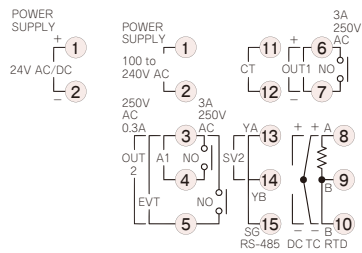

### JCR-33A, JCD-33A

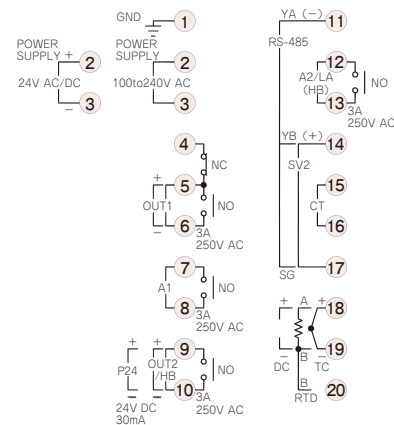

## CT dimensions (Scale: mm)

CTL-6S (for 5A, 10A, 20A)

CTL-12-S36-10L1U (for 50A)

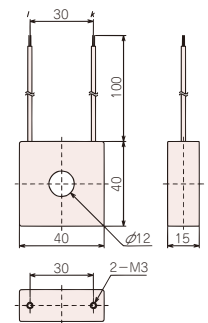
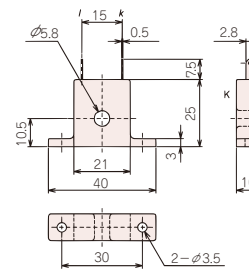

## Other products in the same series

### JCL-33A (W48xH24mm)



### JCM-33A (W72xH72mm)



SAFETY PRECAUTIONS

- To ensure safe and correct use, thoroughly read and understand the manual before using this instrument.
- This instrument is intended to be used for industrial machinery, machine tools and measuring equipment. Verify correct usage after consulting purpose of use with our agency or main office. (Never use this instrument for medical purposes with which human lives are involved.)
- External protection devices such as protection equipment against excessive temperature rise, etc. must be installed, as malfunction of this product could result in serious damage to the system or injury to personnel. Also proper periodic maintenance is required.
- This instrument must be used under the conditions and environment described in the manual. Shinko Technos Co., Ltd. does not accept liability for any injury, loss of life or damage occurring due to the instrument being used under conditions not otherwise stated in this manual.

## Caution with respect to Export Trade Control Ordinance

To avoid this instrument from being used as a component in, or as being utilized in the manufacture of weapons of mass destruction (i.e. military applications, military equipment, etc.), please investigate the end users and the final use of this instrument. In the case of resale, ensure that this instrument is not illegally exported.

· This catalog is as of November 2009 and its contents are subject to change without notice.  
· If you have any inquiries, please consult us or our agency.

## SHINKO TECHNOS CO., LTD. OVERSEAS DIVISION

Reg. Office : 2-5-1, Senbahigashi, Minoo, Osaka, 562-0035, Japan  
Tel : 81-72-727-6100  
Fax : 81-72-727-7006  
URL : <http://www.shinko-technos.co.jp>  
E-mail : [overseas@shinko-technos.co.jp](mailto:overseas@shinko-technos.co.jp)